

▼ Shown: **STB-101H**



Quick, Safe and Wrinkle-free Bending



'One Shot' and 'Sweep'

One shot shoes give up to a 90° bend without resetting.





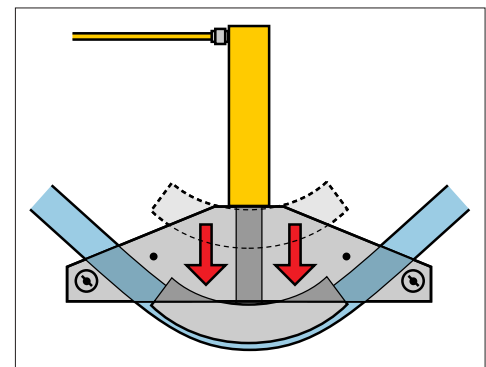

Sweep shoes are used where increased radii are required for multiple parallel pipe installations.

- Makes smooth, wrinkle-free bends
- Sets include cylinder, hose and manual, air or electric pump
- Sets are also available without hydraulics
- Bending shoes and bending frame are lightweight, heat-treated aluminum
- All sets include sturdy steel storage case
- All sets include BZ-12091 angle indicator for accurate bending
- BZ-12377 Shoe Lock Pin included in every set
- Eject-O-Matic™ benders (STB-202 models) use a double-acting cylinder to eject pipe from the bending shoe



▲ Typical one shot bending operation.

▼ SELECTION CHART

Pipe Range		Set Model Number	Hand Pump*	Air Pump*	Electric Pump*	Cylinder*	Hose*	Steel Case*	Saddle	Weight (includes steel case)
One Shot	Sweep									(lbs)
1/2 - 2	-	STB-101X	-	-	-	-	-	CM-4	A-12	88
		STB-101N	-	-	-	RC-1010	HC-7206	CM-4	A-12	105
		STB-101H	P-392	-	-	RC-1010	HC-7206	CM-4	A-12	114
		STB-101A	-	PATG-1102N	-	RC-1010	HC-7206	CM-4	A-12	119
		STB-101B	-	-	PUJ-1200B ²⁾	RC-1010	HC-7206	CM-4	A-12	127
1 - 2	2 1/2 - 4	STB-221X	-	-	-	-	-	CM-7	A-29	229
		STB-221N	-	-	-	RC-2510	HC-7206	CM-7	A-29	263
		STB-221H	P-80	-	-	RC-2510	HC-7206	CM-7	A-29	286
1 1/4 - 4	-	STB-202X ¹⁾	-	-	-	-	-	CM-7	A-29	316
		STB-202N ¹⁾	-	-	-	RR-3014	HC-7206 (2x)	CM-7	A-29	383
		STB-202B ¹⁾	-	-	ZU4408SB ²⁾	RR-3014	HC-7206 (2x)	CM-7	A-29	467

* See corresponding sections of this catalog for more detailed specifications.

¹⁾ Eject-O-Matic™ ²⁾ For 230 volt applications change the last digit of Set Model Number from "B" to "E".

Pipe Bender Sets

Nominal pipe size (outside dia.) (in)	Wall Thickness (in)	Schedule Pipe *	Pipe Bend Inside Radius (in)	STB-101	STB-221	STB-202	One Shot Bending Shoe Model Number	Sweep Bending Shoe Model Number
				1/2 - 2 One Shot	1-2 One Shot 2 1/2 - 4 Sweep	1 1/4 - 4 One Shot		
1/2 (.840)	.109	40	2 7/8	Yes	-	-	BZ-12011	-
	.147	80		Yes	-	-		
	.187	160		WS	-	-		
	.294	DEH		WS	-	-		
3/4 (1.050)	.113	40	4	Yes	-	-	BZ-12021	-
	.154	80		Yes	-	-		
	.218	160		WS	-	-		
	.308	DEH		WS	-	-		
1 (1.315)	.133	40	5 1/8	Yes	Yes	-	BZ-12031	-
	.179	80		Yes	Yes	-		
	.250	160		WS	WS	-		
	.358	DEH		-	WS	-		
1 1/4 (1.660)	.140	40	6 7/16	Yes	Yes	Yes	BZ-12041	-
	.191	80		Yes	Yes	Yes		
	.250	160		WS	WS	Yes		
	.342	DEH		-	WS	WS		
1 1/2 (1.900)	.145	40	7 5/16	Yes	Yes	Yes	BZ-12051	-
	.200	80		Yes	Yes	Yes		
	.281	160		WS	WS	Yes		
	.400	DEH		-	WS	WS		
2 (2.375)	.154	40	8 5/16	Yes	Yes	Yes	BZ-12061	-
	.218	80		-	Yes	Yes		
	.343	160		-	WS	Yes		
2 1/2 (2.875)	.203	40	9 1/2	-	Yes	Yes	BZ-12341	BZ-12382
	.276	80		-	WS	Yes		
	.375	160		-	WS	Yes		
3 (3.500)	.216	40	11 1/4	-	Yes	Yes	BZ-12351	BZ-12383
	.300	80		-	WS	Yes		
3 1/2 (4.000)	.226	40	15 1/2	-	Yes	Yes	BZ-12391	BZ-12384
	.318	80		-	WS	Yes		
4 (4.500)	.237	40	17 3/4	-	Yes	Yes	BZ-12392	BZ-12385
	.337	80		-	-	Yes		

*Schedule Pipe: 40 = Standard; 80 = Extra Heavy; 160 = Double Extra Heavy;

DEH = Double Extra Heavy (slightly thicker than 160);

WS = Can be bent by using wider spacing for swivel shoes.

STB Series



Nominal Pipe Size:

0.5-4 inches

Maximum Bend Angle:

90°

Maximum Operating Pressure:

10,000 psi



All bender sets are designed to bend mild steel pipe. For other material please consult Enerpac.

Frame Assembly	Pivot Pin (2x incl)	Pivot Shoes (2x incl)	One Shot or Sweep ³⁾ Bending Shoes included									Set Model Number	
BZ-12371	BZ-12375	BZ-12071	BZ-12011	BZ-12021	BZ-12031	BZ-12041	BZ-12051	BZ-12061	-	-	STB-101X		
												STB-101N	
													STB-101H
													STB-101A
													STB-101B
BZ-12372	BZ-12376	BZ-13401	BZ-12031	BZ-12041	BZ-12051	BZ-12061	BZ-12382 ³⁾	BZ-12383 ³⁾	BZ-12384 ³⁾	BZ-12385 ³⁾	STB-221X		
											STB-221N		
												STB-221H	
BZ-12374	BZ-12376	BZ-13401	-	BZ-12041	BZ-12051	BZ-12061	BZ-12341	BZ-12351	BZ-12391	BZ-12392	STB-202X ¹⁾		
											STB-202N ¹⁾		
												STB-202B ¹⁾	

³⁾ Shoes are Sweep, all other shoes are One Shot.